

Appendix A

Suggested updates to Northeastern Regional ITS Architecture

Stakeholders

1. Change **Chicago Area Transportation Study (CATS)** to *Chicago Metropolitan Agency for Planning (CMAP)*
2. **DuPage County Maintenance** renamed to *DuPage County Highway Maintenance Dispatch*
3. Description for **DuPage County Division of Transportation** should be changed to: *The Division of Transportation is responsible for the construction and maintenance of the County Highway system which serves the over 900,000 residents of DuPage County. The Division of Transportation maintains approximately 220 miles of arterial highway and 50 miles of recreational trails in DuPage County.*
4. **DuPage County Office of Emergency Management** should be renamed as *DuPage County Office of Homeland Security and Emergency Management: The Office of Homeland Security and Emergency Management coordinates the operations of all governmental and non-governmental agencies in time of emergency and provides the unique skills and capabilities related to disaster preparedness.*
5. **DuPage County Sheriff** description should be changed to: *The Sheriff is the chief law enforcement officer in DuPage County. The Office directly services the unincorporated areas of the county providing public safety dispatch and emergency call taking.*
6. **Private Sector Maintenance Contractor** renamed as *Private Sector Maintenance Contractor Dispatch*

Subsystems

1. **DuPage County TMC** status should be changed to *Existing*
2. **IDOT District 1 Bureau of Traffic Signal Unit Roadside Equipment** should be renamed as: *IDOT District 1 Bureau of Traffic Signal Unit Field Equipment* and its description as: *Roadside equipment for IDOT District 1 Bureau of Traffic Signal Unit. Includes traffic signals (including detection), EVP, CCTV cameras, and arterial DMS.*
3. **Illinois Gateway** should be under IDOT ITS Program office and its status should be made as *Existing*
4. **Illinois Transit Hub** status should be changed to *Existing*
5. **ISTHA TCM (TIMS)** status should be changed to *Existing*

6. **ISTHA TMC Roadside Equipment** should be renamed as *ISTHA TMC Field Equipment*
7. **Metra Parking Management Guidance System** status should be changed to Existing
8. **Metra PMGS Signs** status should be changed to Existing
9. **Metra Train Information Management System** description should be changed to: *The Metra TIMS system collects location and schedule adherence information from trains, primarily for passenger information use. This includes the Metra Hub that feeds the Illinois Transit Hub.*
10. **Municipal TMCs** status should be changed to Existing
11. **Northeastern Illinois 511 System** should be under IDOT ITS Program Office
12. **Pace IBS** status should be changed to Existing and description should be changed to: *Pace Intelligent Bus System, a centralized dispatch computer system which supports physically distributed dispatchers. The IBS includes not only the dispatch system, but also AVL, on-board processors, audio and visual information display, passenger counting. Provides bus schedule adherence data for driving BusInfo Signs. This includes the Pace Hub that feeds the Illinois Transit Hub.*
13. **Pace Transit Bus Vehicles** description should be changed to *Fixed route transit vehicles operated by Pace. Contain automated vehicle location, passenger counting and, in the future, transit priority signal transmitters.*
14. **Regional Event Facilities** description should be changed to: *Represents the various event facilities in the region that are generators of planned events with significant traffic or transit impact. Examples are Universities and Colleges. etc.*
15. **DuPage Centralized Paratransit Dispatch** should be renamed as *Ride- DuPage Dispatch*
16. **DuPage Paratransit Vehicles** should be renamed as *Ride-DuPage Vehicles*
17. **Illinois State Operations Center** should be renamed as *Statewide Emergency Operations Center*
18. **Trucking Organizations** should add the *Trade Regulatory Agencies* as its Architecture Entity

Market Packages

Market Package	Status	Entity to be Included
ATMS02		ISTHA I-Pass Toll Plazas
ATMS06	<i>Planned</i>	DuPage County Field Equipment included as
		DuPage County TMC
ATMS07	<i>Planned</i>	DuPage County Field Equipment included as
		DuPage County TMC
ATMS08		ISTHA TMC Field Equipment

Market Package	Status	Entity to be Included
	<i>Planned</i>	Municipal/Township Maintenance
		DuPage County TMC
		Private Sector Maintenance Contractor Dispatch
		Utility Company Dispatch
ATMS10	<i>Existing</i>	
ATMS13	<i>Planned</i>	DuPage TMC
ATMS14	<i>Existing</i>	Metra Wayside Equipment
ATMS15	<i>Potential</i>	DuPage County TMC
		Illinois Gateway
		Municipal TMCs
ATMS16	<i>Planned</i>	Metra Parking Management Guidance System
		Satellite TMC OHare Airport
		Vehicles
MC01	<i>Planned</i>	IDOT District 1 Bureau of Construction
		Municipal/Township Maintenance
		Private Sector Maintenance Contractor Dispatch
		Utility Company Dispatch
		Vehicles
MC03	<i>Existing</i>	DuPage County Highway Maintenance Dispatch
		DuPage County Sheriff Communication Center
		ISTHA TMC (TIMS)
		ISTHA TMC Field Equipment
		Private ISPs – Travel Information Services
MC04	<i>Existing</i>	IDOT District 1 Bureau of Construction
		IDOT District 1 Traffic Signal Unit
		IDOT District 1 Maintenance Management
		IDOT District 1 Traffic Systems Center (TSC)
		ISTHA Maintenance and Construction
		ISTHA TMC (TIMS)
		Media
	Ride-DuPage Dispatch	
	<i>Planned</i>	DuPage County TMC
		Weather Services
MC06	<i>Existing</i>	DuPage County Sheriff Communications Center
		Municipal TMCs
	<i>Planned</i>	Private Sector Maintenance Contractor Dispatch
MC07	<i>Existing</i>	IDOT District 1 Bureau of Construction
		IDOT District 1 Traffic Signal Unit Field Equipment
		IDOT District 1 ComCenter Field Equipment
		IDOT District 1 Traffic Systems Center (TSC)
		IDOT District 1 Traffic Systems Center (TSC) Field Equipment
		Municipal TMCs
		Private Sector Maintenance Contractor Dispatch
	Utility Company Dispatch	
	<i>Planned</i>	DuPage County TMC
MC08	<i>Existing</i>	Municipal TMCs
	<i>Planned</i>	DuPage County Field Equipment
MC10	<i>Planned</i>	DuPage County TMC
		DuPage County Highway Maintenance Dispatch
		IDOT District 1 Bureau of Traffic Signal Unit
		Illinois Gateway

Market Package	Status	Entity to be Included
		Municipal / Township Maintenance
		Private Sector Maintenance Contractor Dispatch
ATIS5	<i>Existing</i>	Metra Consolidated Control Facility
		Municipal Public Safety Dispatch
		Municipal Transit Operations
		Public/Non-Profit Paratransit Services
APTS7	<i>Planned</i>	DuPage County Field Equipment
		DuPage County TMC
		Municipal TMCs
		Satellite TMC OHare Airport
APTS8	<i>Planned</i>	Private ISPs – Travel Information Services
	<i>Potential</i>	Ride-DuPage Dispatch
ATIS1	<i>Existing</i>	IDOT District 1 ComCenter
		IDOT District 1 Traffic Systems Center (TSC)
		ISTHA TMC (TIMS)
	<i>Potential</i>	DuPage County TMC
		IDOT District 1 ComCenter
		Illinois Gateway
		Municipal TMCs
		Municipal Transit Operations
ATIS2	<i>Existing</i>	Regional Transportation Authority Travel Information Center (TIC)
EM01	<i>Existing</i>	Highway Emergency Lane Patrol Vehicles
		IDOT Emergency Traffic Patrol Vehicles
	<i>Planned</i>	DuPage County EOC
		DuPage County Sheriff Communications Center
		DuPage County TMC
		Illinois Emergency Traffic Patrol (ETP)
		IDOT Emergency Traffic Patrol Vehicles
		Illinois State Police Dispatch (District 2,5 and Chicago)
		Illinois State Police District 15 Operations Desk
		ISTHA TMC (TIMS)
		Statewide Emergency Operations Center
EM02	<i>Existing</i>	DuPage County Field Equipment
		IDOT District 1 Bureau of Traffic Signal Unit Field Equipment
		IDOT District 1 ComCenter
		IDOT District 1 ComCenter Field Equipment
		Highway Emergency Lane Patrol Vehicles
		Illinois State Police Vehicles
		Municipal EMCs
		Municipal Public Safety Dispatch
		Regional Hospitals
EM04	<i>Existing</i>	DuPage County EOC
		IDOT District 1 ComCenter
		Private Tow and Recovery Operations
EM06	<i>Existing</i>	DuPage County EOC
		DuPage County Field Equipment
		DuPage County Sheriff Communications Center
		DuPage County TMC
		Municipal EMCs
		Municipal Public Safety Dispatch
		Municipal TMCs

Market Package	Status	Entity to be Included
EM08	<i>Existing</i>	Private ISPs – Travel Information Services
		Statewide Emergency Operations Center
		User Personal Computing Devices
		DuPage County EOC
		DuPage County Highway Maintenance Dispatch
		DuPage County Sheriff Communications Center
		DuPage County TMC
		IDOT District 1 ComCenter
		IDOT District 1 Maintenance Management
		Illinois State Police Dispatch (Districts 2,5 and Chicago)
		Illinois State Police District 15 Operations Desk
		ISTHA Dispatch Center
		ISTHA Maintenance and Construction
		ISTHA TMC (TIMS)
		Municipal EMCs
		Municipal Public Safety Dispatch
		Municipal TMC
		Municipal Transit Operations
		Municipal/Township Maintenance
Statewide Emergency Operations Center		
EM09	<i>Potential</i>	AMTRAK Rail
		DuPage County EOC
		DuPage County Highway Maintenance Dispatch
		DuPage County Sheriff Communications Center
		DuPage County TMC
		IDOT District 1 Bureau of Traffic – Expressway Operations Unit
		IDOT District 1 Bureau of Traffic Signal Unit
		IDOT District 1 ComCenter
		IDOT Emergency Traffic Patrol (ETP)
		Illinois State Police Dispatch (District 2,5 and Chicago)
		Illinois State Police District 15 Operations Desk
		ISTHA Dispatch Center
		ISTHA TMC(TIMs)
		Metra Consolidated Control Facility
		Municipal EMCs
		Municipal Public Safety Dispatch
		Municipal TMCs
		Municipal Transit Operations
		Pace Paratransit Dispatch
		Private Bus Dispatch
		Private Taxi Dispatch
		Ride-DuPage Dispatch
		Satellite TMC OHare Airport
Statewide Emergency Operations Center		
AD1	<i>Existing</i>	IDOT District 1 ComCenter
		IDOT District 1 Traffic Systems Center (TSC)
		Illinois Gateway
		Illinois Transit Hub
	<i>Planned</i>	Academic/Research Organizations Data Warehouse
		DuPage County TMC
		Municipal TMCs
		Northeastern Illinois Regional Data Archive

Market Package	Status	Entity to be Included
AD2	Existing	Academic/Research Organizations Data Warehouse
		Illinois Gateway
		Northeastern Illinois Regional Data Archive

Functional Requirements

Element	Architecture Entity	Equipment Package
DuPage County EOC	Emergency Management / Archived Data User System	Incident Command
		Emergency Evacuation Support
		Emergency Commercial Vehicle Response
		TMC Traffic Information Dissemination
DuPage County Field Equipment	Roadway Subsystem	Roadway Speed Monitoring
		Roadway Data Collection
DuPage County Sheriff Communications Center	Emergency Management	Emergency Routing
		Emergency Evacuation Support
DuPage County TMC	Traffic Management/ Archived Data User System	TMC Evacuation Support
		Rail Operations Coordination
		TMC Speed Monitoring
		TMC Multimodal Coordination
		Traffic Data Collection
IDOT District 1 Bureau of Traffic Signal Unit Field Equipment	Roadway Subsystem	Roadway Signal Priority
		Roadway Traffic Information Dissemination
		Roadway Work Zone Traffic Control
IDOT District 1 ComCenter Field Equipment	Roadway Subsystem	Field Barrier System Control
IDOT District 1 Traffic Systems Center (TSC)	Information Service Provider / traffic Management	Roadway Incident Detection
IDOT District 1 Traffic Systems Center (TSC) Field Equipment	Roadway Subsystem	Roadway Work Zone Traffic Control
ISTHA I-Pass Toll Plazas	Toll Collection	Roadway Probe Beacons
Municipal EMCs	Emergency Management	Emergency Evacuation Support
Municipal Public Safety Dispatch	Emergency Management	Emergency Routing
		Incident Command
		TMC Traffic Information Dissemination
Municipal TMC	Traffic Management	TMC Evacuation Support
		HRI Traffic Management
		Rail Operations Coordination
		TMC Multimodal Coordination
		MCM Work Activity Coordination
Municipal/ Township Maintenance	Maintenance and Construction Management	MCM Work Activity Coordination
Pace Transit Bus Vehicles	Transit Vehicle Subsystem	On-board Transit Fare and Load Management
Private Bus Dispatch	Transit Management	Transit Garage Maintenance
		On-Board Fixed Route Schedule Management
		On-Board Paratransit Operations
Private ISPs – Travel Information Services	Information Service Provider	Infrastructure Provided Trip Planning
Private Taxi Dispatch	Transit Management	Transit Vehicle Operator Scheduling

Other Considerations:

1. In the Private Taxi Dispatch entity's equipment packages, the description for Transit Garage Operations suites more to Transit Vehicle Operator Scheduling.
2. The ISTHA has RWIS capabilities which need to be incorporated in the functionalities of ISTHA TMC (TIMS), ISTHA TMC Roadside Equipment and the subsequent flows between these elements.
3. ISTHA also has a GIS database of its inventory which needs to be added to architecture.
4. Lake County TMC is now named as Lake County PASSAGE
5. DuPage County EOC should have the additional subsystem capabilities of "Traffic Management" and "Archived Data User Systems"

Appendix B

Stakeholder List

Last Name	First Name	Organization	Job Title
Ackerman	Ron	West Chicago Fire Protection District	Fire Chief
Adkins	Ray	City of Naperville	
Anders	Mike	City of Naperville	Traffic Section Supervisor
Anderson	Wes	Village of Lombard	Director of Public Works
Anderson	Mimi	City of Wood Dale	Special Events Coordinator
Bacidore	Jeff	City of Elmhurst	Deputy Fire Chief
Barber	David	Village of Downers Grove	Director of Public Works
Beckman	William J.	Village of Hanover Park	Village Engineer
Benda	John	Illinois State Toll Highway Authority	Manager of Maintenance and Traffic
Berk	Greg	City of Wheaton	Fire Chief
Bodane	Mark	Carol Stream Fire Protection District	Fire Chief
Boehm	Rick	Village of Oak Brook	Village Manager
Bolton	Mike	PACE	
Bourke	Paul	Christopher B. Burke Engineering, Ltd.	City Engineer Oakbrook Terrace
Calvert	Lance	Village of Burr Ridge	Village Engineer
Carlson	Ronald	IEMA District 4	Regional Coordinator
Charnicky	Dave	Illinois State Police, District 15	Lieutenant
Coffinbargar	Steve	Kane County DOT	Chief of Planning and Programming
Crosson	W. Daniel	Christopher B. Burke Engineering, Ltd.	Village of Glendale Heights Engineer
Curneal	Rick	DuPage Mayors and Managers Conference	Transportation & Planning Director
Dale	Senior	Village of Bartlett	Director of Public Works
Damron	Harold	Will County Emergency Management Agency	Chief Deputy Director
Darnell	James	James J. Benes & Assoc., Inc.	City of Warrenville Engineer
Dean	Robert	City of Naperville	Transportation Planner
Dial	David	City of Naperville	Police Chief
Dimenza	Phil	Winfield Fire Protection District	Fire Chief
Doherty	James	City of Elmhurst	
Drucker	Harvey	Argonne National Laboratory	Associate Laboratory Director
Durfey	Dale	Village of Oak Brook	Village Engineer
Espedido	Rudy	Village of Addison	Village Engineer
Ewing	Tom	Argonne National Laboratory	Associate Division Director
Farris	Dave	Village of Carol Stream	Carol Stream Fire
Fera	Dorin	Village of Downers Grove	Traffic Engineering Manager
Fichtner	Paul	DuPage County Board	County Board Member District 1
Field	Mark	City of Wheaton	Police Chief
Flatter	Robert	City of West Chicago	Director of Public Works
Foster	Donald	Glen Ellyn Public Work Department	Director
Freeman	Thomas	Woodridge-Lisle Fire Protection District	Chief
Fritz	Jeff	Village of Bloomingdale Police Department	
Galas	Jeff	IDOT Traffic Systems Center	Manager
Geils	Mike	Will County Sheriff	Sergent
Giammarese	Frank	Village of Bloomingdale Police Department	
Glassman	Ken	Illinois State Toll Highway Authority	Traffic Operations Manager
Goergen	Tim	Village of Bloomingdale Police Department	Police Chief
Gomez	Manny	Kane County DOT	Assistant Director
Gortner	Vince	City of Naperville	Traffic Section Commander
Greene	Bob	City of Aurora	Traffic Engineer
Greiner	Tom	City of Aurora	Administrative Support Officer
Griffith	Jim	Illinois State Police, District 2	
Grossman	Reid	City of Wheaton	Police Chief
Haukedahl	Tami	Illinois State Police, District 15	District Commander
Hedrich	Jeffrey	Illinois State Police, District 2	District Commander
Heher	Scott	Village of Itasca	Chief of Police
Heine	Kevin	Bartlett Fire Protection District	Fire Chief

Last Name	First Name	Organization	Job Title
Heither	Craig	Chicago Area Transportation Study	Associate for System Evaluation
Heniff	Bill	Village of Lombard	Senior Planner
Higgins	Michael	Village of Roselle	Village Engineer
Holm	Gary	City of Wood Dale	Director of City Services
Horwath	Ray	Will County Sheriff	Director
Howard	Bill	Naperville Towing	Owner
Hughes	Pat		Motorola
Hynes	Andy	City of Naperville	Project Engineer
Jezierny	Rich	Cook County Highway Dept.	Division Head
Jirsa	Don	City of Wheaton	Batallion Chief
Juskelis	Vydas	Village of Villa Park	Director of Public Works
Kaupas	Paul	Will County Sheriff	Sheriff
Keating	Cori	City of Elmhurst	City Engineer
Keating	Mary	DuPage County Human Services	Assistant Administrator
Khan	Zill	Village of Woodridge	Director of Public Works
Khawaja	Anthony	Lake County DOT	County Traffic Engineer
Killinger	Patti	Will County Highway Dept.	Civil Engineer
Kirts	Joe	DuPage County OEM	Deputy
Knudsen	Jim	Village of Carol Stream	Director of Engineering Services
Kopp	Mike	City of Elmhurst	Fire Chief
Kos	John	DuPage County DOT	Director
Krestan	Keith	Woodridge-Lisle Fire Protection District	Bureau Chief Training and Safety
Kuehnlenz	Paul	Village of Bensenville	Village Engineer
Kutzmark	Tam	DuPage Mayors and Managers Conference	Transportation Project Manager
Laffey	Steve	Illinois Commerce Commission	Rail Safety Specialist
Longmeyer	George	DU-COMM	Executive Director
Loper	John	DuPage County	Principal Planner
Love	Duana	RTA	Program Manager, Engineering & Technology
Lozar	John	DU-COMM	Technical Services Manager
Lynch	Daniel	Christopher B. Burke Engineering, Ltd.	Engineer for Clarendon Hills, Darien, Wayne
Marchi	Michael	Village of Bloomingdale	Director of Village Services
McGreevy	Sean	DuPage County Sheriff	
McGrew	Kim	City of Elmhurst	
Mefferd	Thomas	DuPage County OEM	Coordinator
Mendrick	James	DuPage County Sheriff	Commander
Mentjes	Dean	Federal Highway Administration	Mobility Engineer
Minix	Bob	Village of Glen Ellyn	Professional Engineer
Mohammed	Taqhi	Pace	Transportation Engineer
Morton	Robert	Oak Brook Fire Department	Battalion Chief
Mullen	Patrick	City of Naperville	
Murtha	Tom	Chicago Area Transportation Study	
Myers	Ruth	DuPage County Economic Development and Planning	Principal Planner
Neubauer	Steven	City of Elmhurst	Police Chief
Noriega	Noriel	Village of Westmont	Assistant Village Engineer
Oelker	Tim	City of Aurora	Fire Chief
Pawlowicz	Tom	Village of Bolingbrook	Village Engineer
Pelletier	Shawn	Village of Hinsdale	
Peters	Steve	IDOT BEO	Communications Center Manager
Peterson	Ray	Village of Lisle	Public Works Director
Pitstick	Mark	RTA	Division Manager, Planning & Program Support
Powell	William	City of Aurora	Police Chief
Price	Dan	Village of Lombard	GIS Technician
Raffensparger	Scott	Glen Ellyn Fire Company	Fire Chief
Redman	Paul	City of Wheaton	City Engineer
Resnick	Barry	Metra	Planner
Rice	Dan	Chicago Area Transportation Study	Transportation Systems Manager
Rizzo	Jennifer	Village of Downers Grove	
Rodriguez	Jose	CMAP	

Last Name	First Name	Organization	Job Title
Ross	TJ	Pace	
Schatz	Marcie	City of Naperville	
Schoenberg	Daniel	Village of Hinsdale	Village Engineer
Sikaras	Chuck	IDOT ITS Planning and Programming	
Smit	Marie	DU-COMM	Acting Assistant Director
Stead	Mike	Illinois Commerce Commission	Rail Safety Program Administrator
Stefan	Al	Baxter & Woodman	Itasca Village Engineer
Syversen	Bill	DuPage County	Manager of Systems & Programming
Szabo	Tom	Kane County DOT	Traffic Manager
Szczesniak	Jim	O'Hare Airport	
Tokorski	Charles	DuPage County DOT	County Engineer
Tomzik	David	Pace	Supervisor, Long Range Planning
Travia	Steve	IDOT, District One	Traffic Signal Engineer
Tuman	Mike	Christopher B. Burke Engineering, Ltd.	Engineer for Oakbrook Terrace
Tumbali	Gerry	RTA	Manager, Engineering and Technology
Wang	Lei	IDOT, District 1	
Watson	Dan	Rempe Sharpe & Associates, Inc.	Winfield Village Engineer
Wu	John	City of Naperville	Fire Chief
Wu	Phoebe	Cook County Highway Department	Assistant Division Head
Zavattero	David	IDOT ITS Planning and Programming	ITS Program Manager
Ziesemer	David	DuPage County DOT	County Traffic Engineer
Zordan	Alan	Village of Willowbrook	Director of Community Services

Appendix C

DuPage County Sub-regional ITS Architecture Interconnect Diagrams

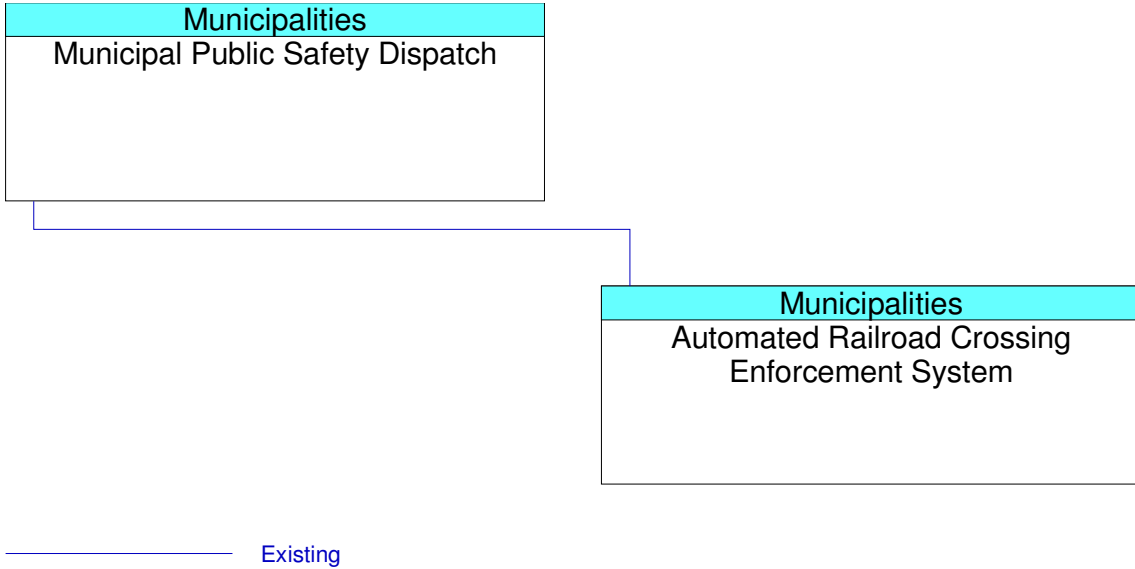

Automated Railroad Crossing Enforcement System

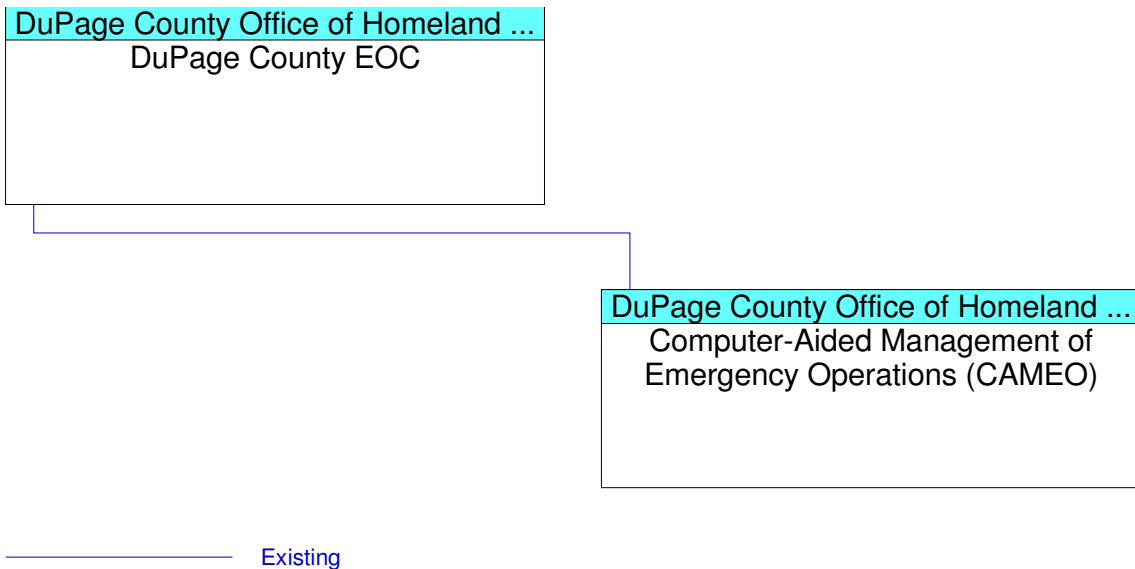

Computer Aided Management of Emergency Operations (CAMEO)

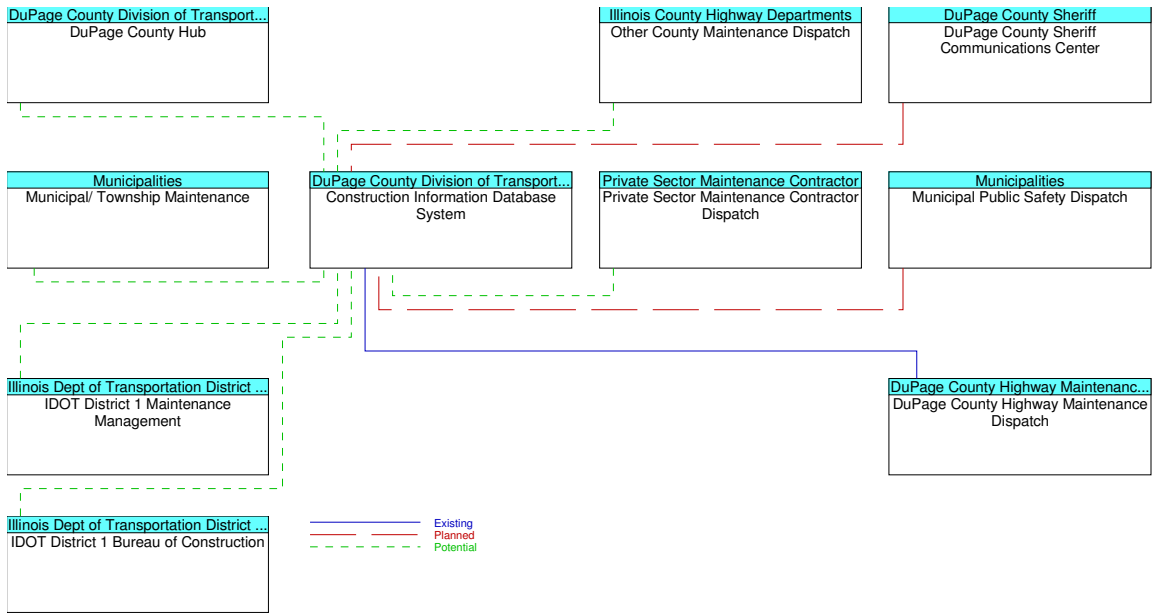

Construction Information Database System

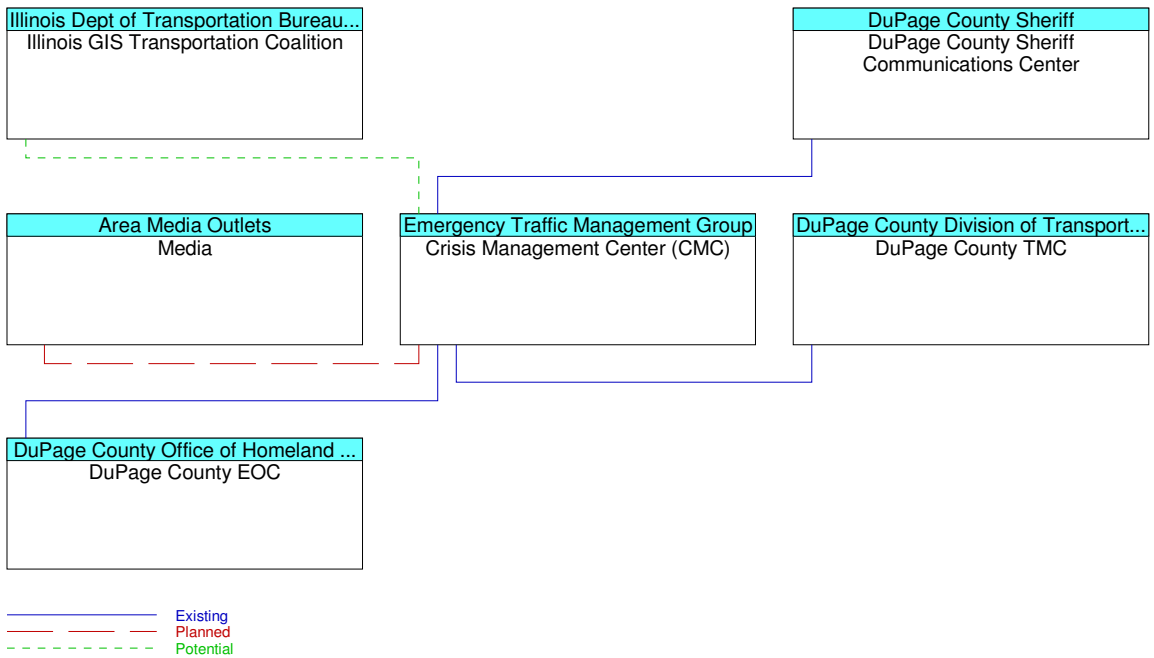

Crisis Management Center

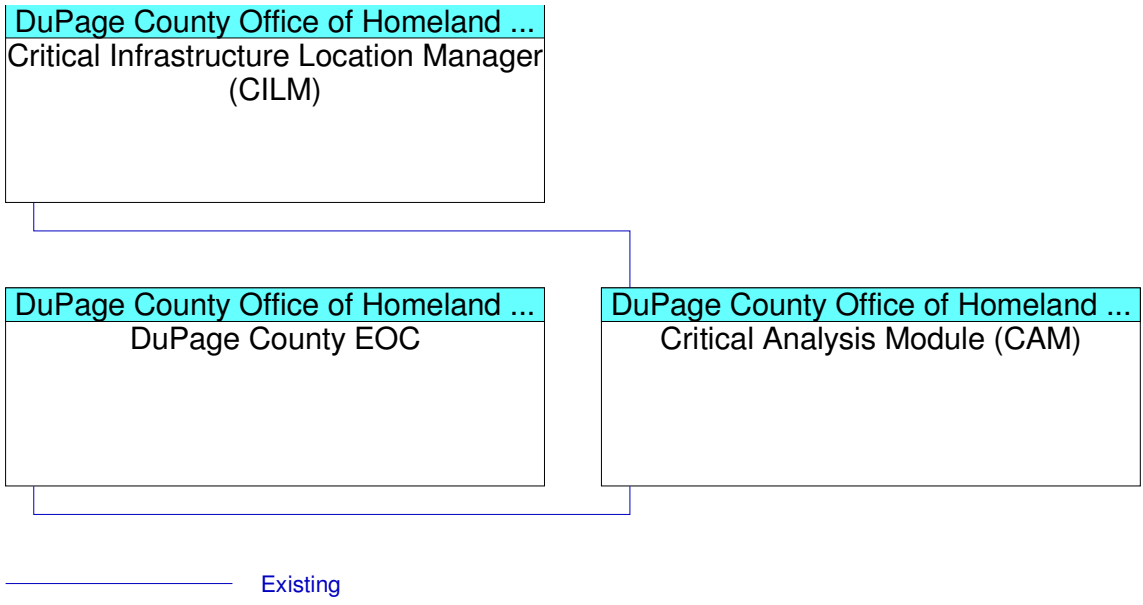

Critical Analysis Module (CAM)

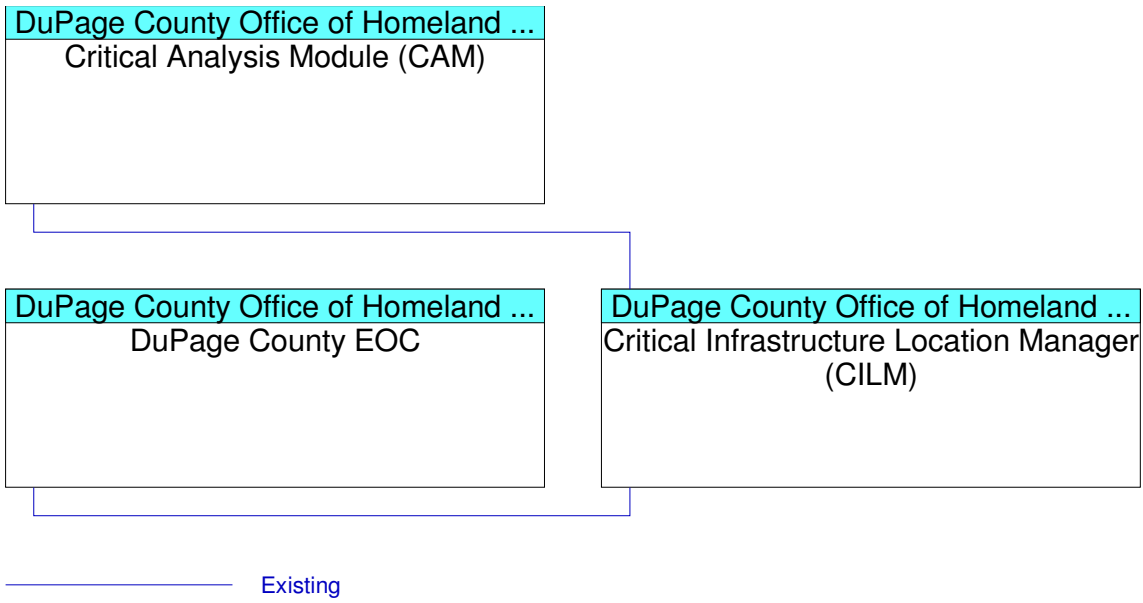

Critical Infrastructure Location Manager (CILM)

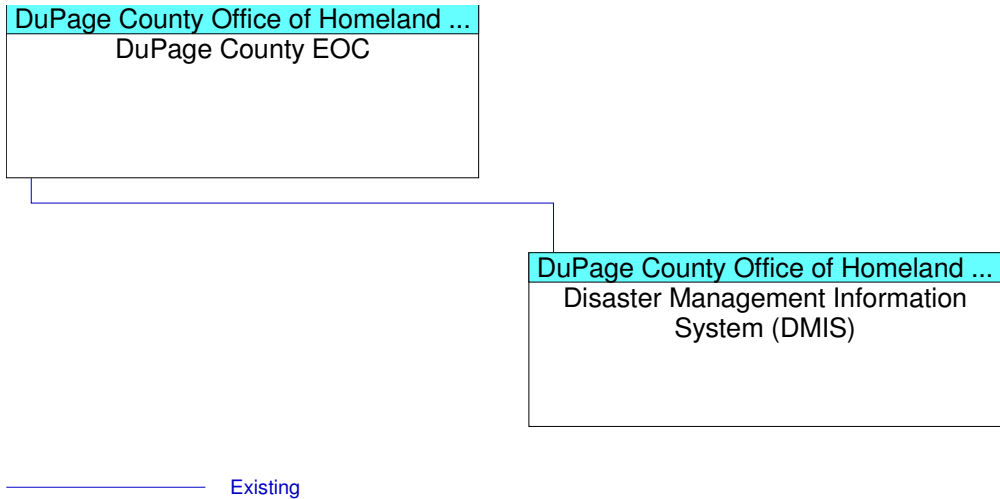

Disaster Management Information System (DMIS)

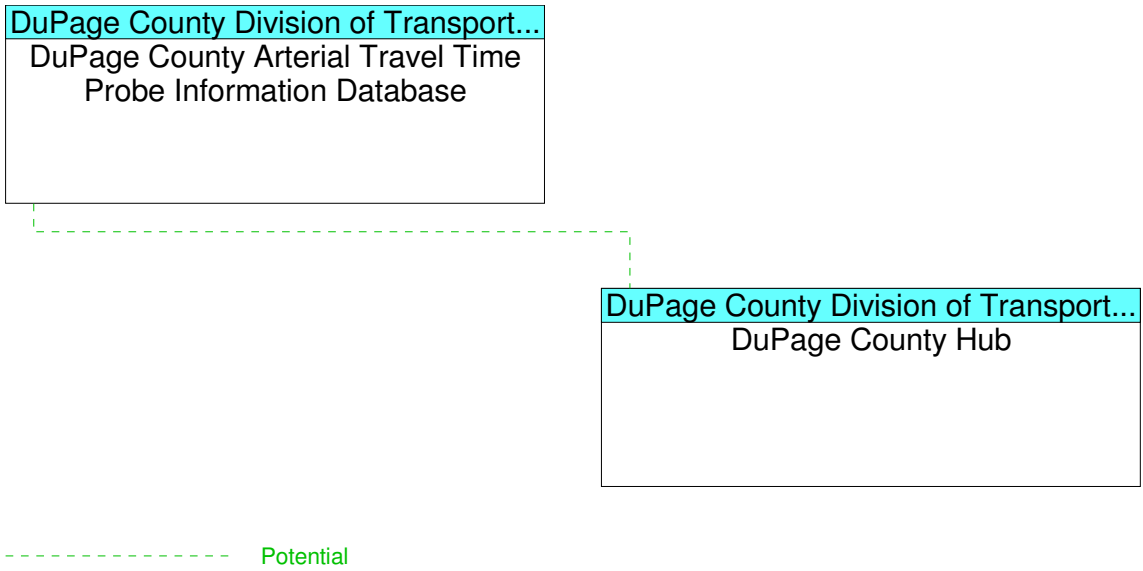

DuPage County Arterial Travel Time Probe Information Database

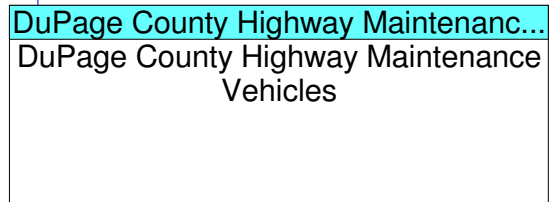
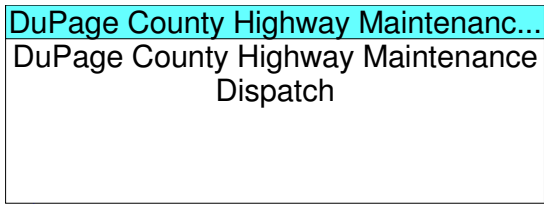

Existing

DuPage County Highway Maintenance Vehicles

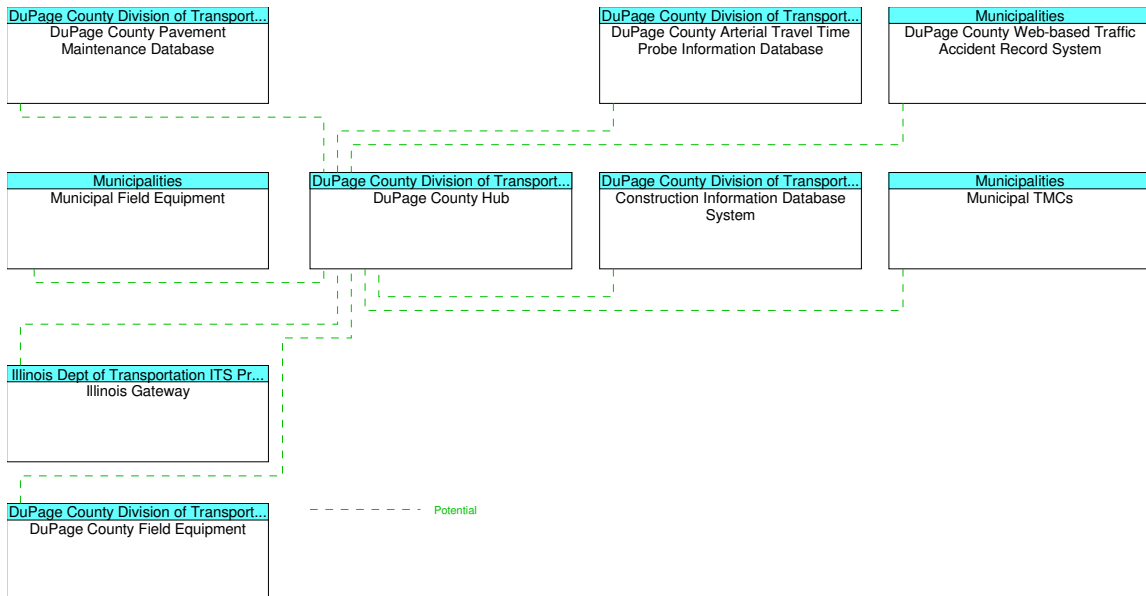

DuPage County Hub

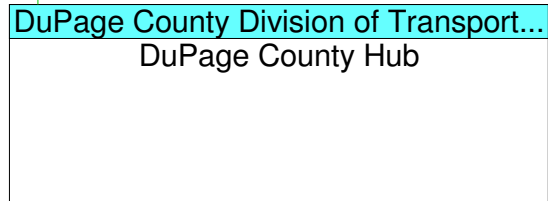
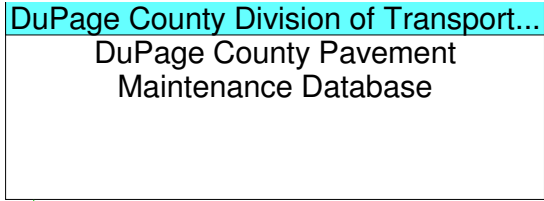

----- Potential

DuPage County Pavement Maintenance Database

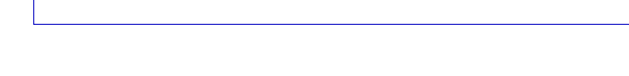
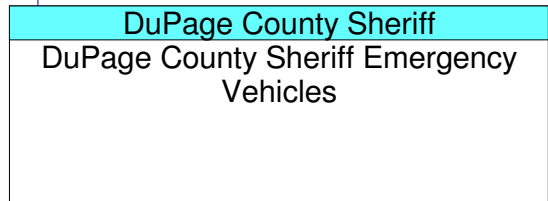
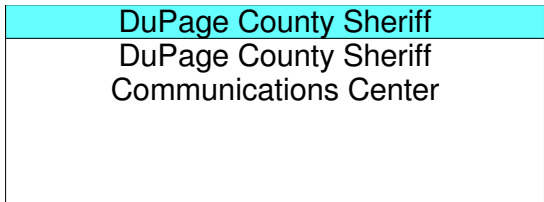

----- Existing

DuPage County Sheriff Emergency Vehicle

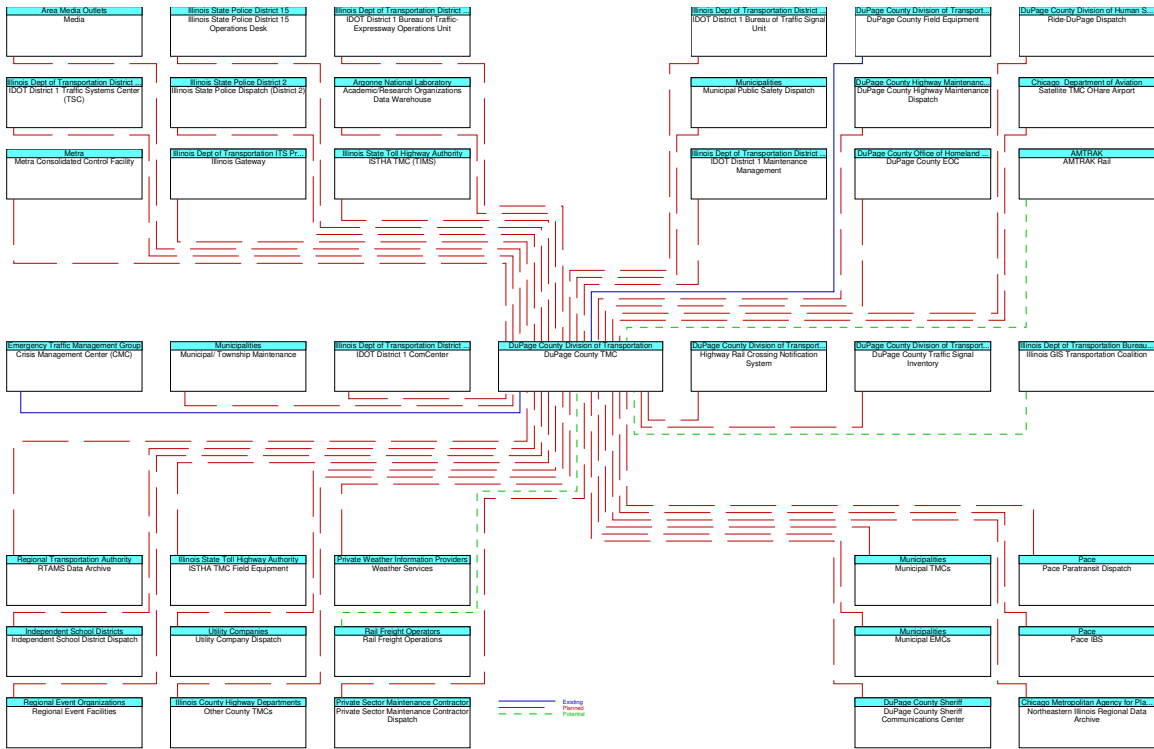

DuPage County TMC

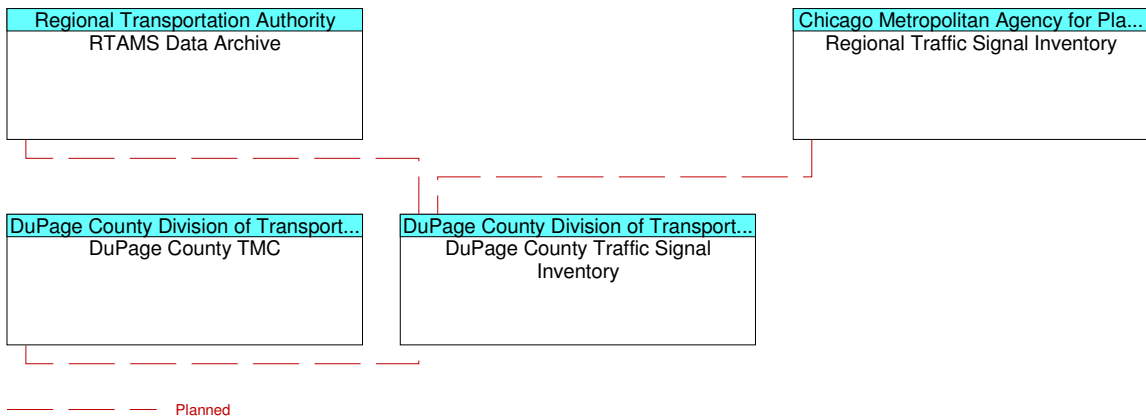

DuPage County Traffic Signal Inventory

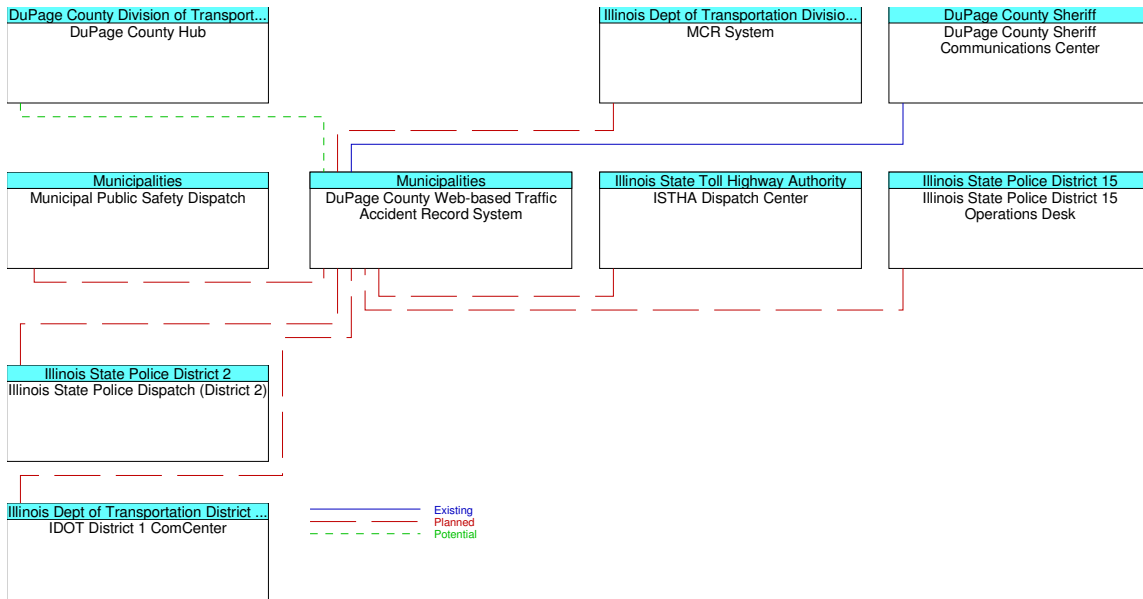

DuPage County Web-based Traffic Accident Record System

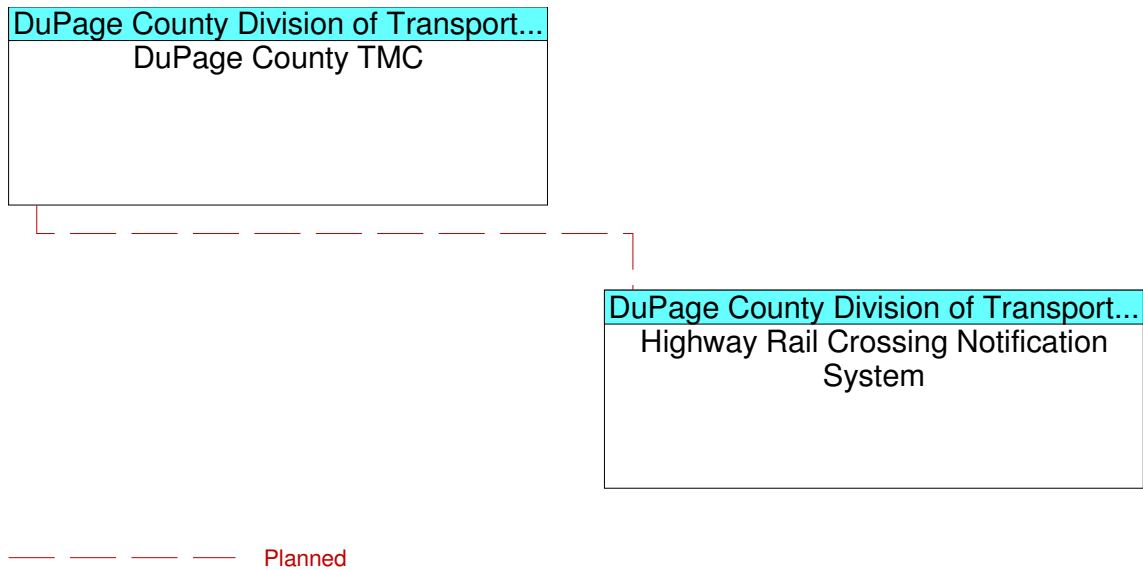

Highway Rail Crossing Notification System

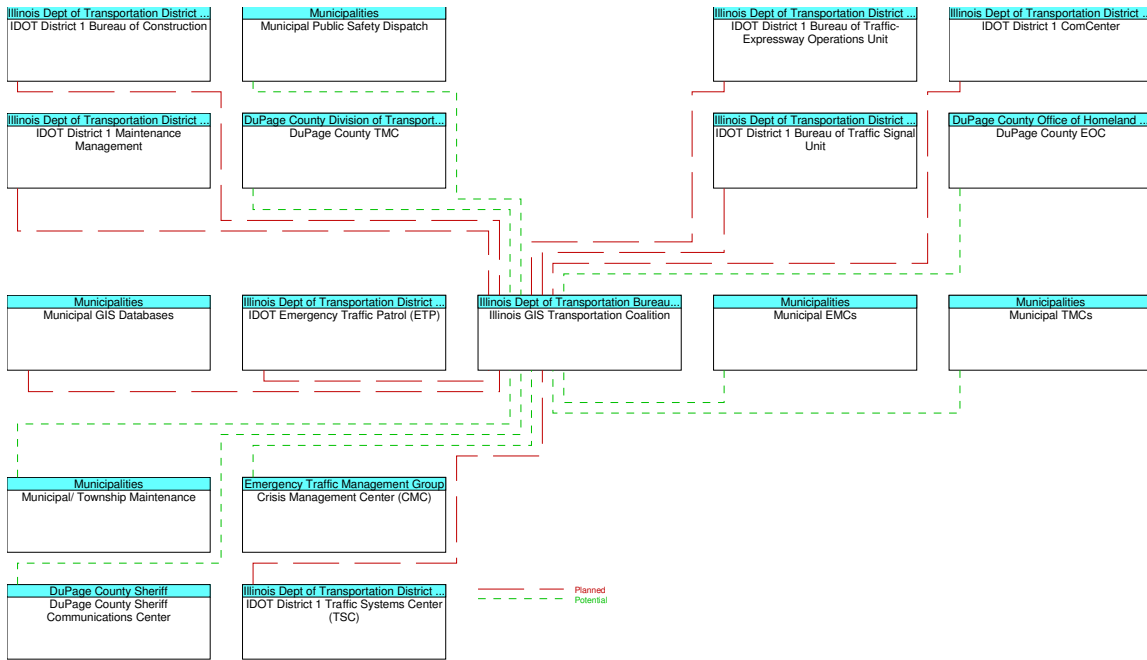

Illinois GIS Transportation Coalition

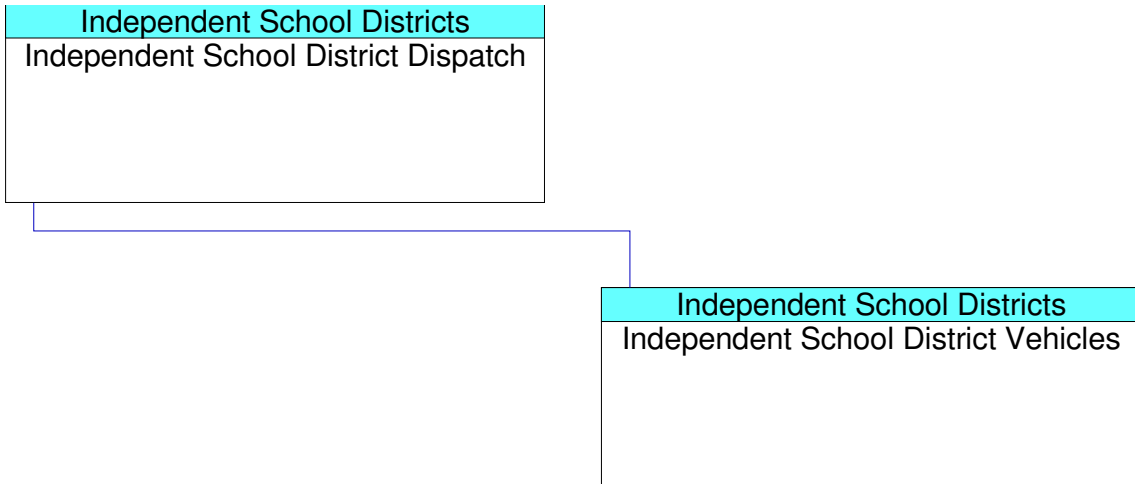

Independent School District Vehicles

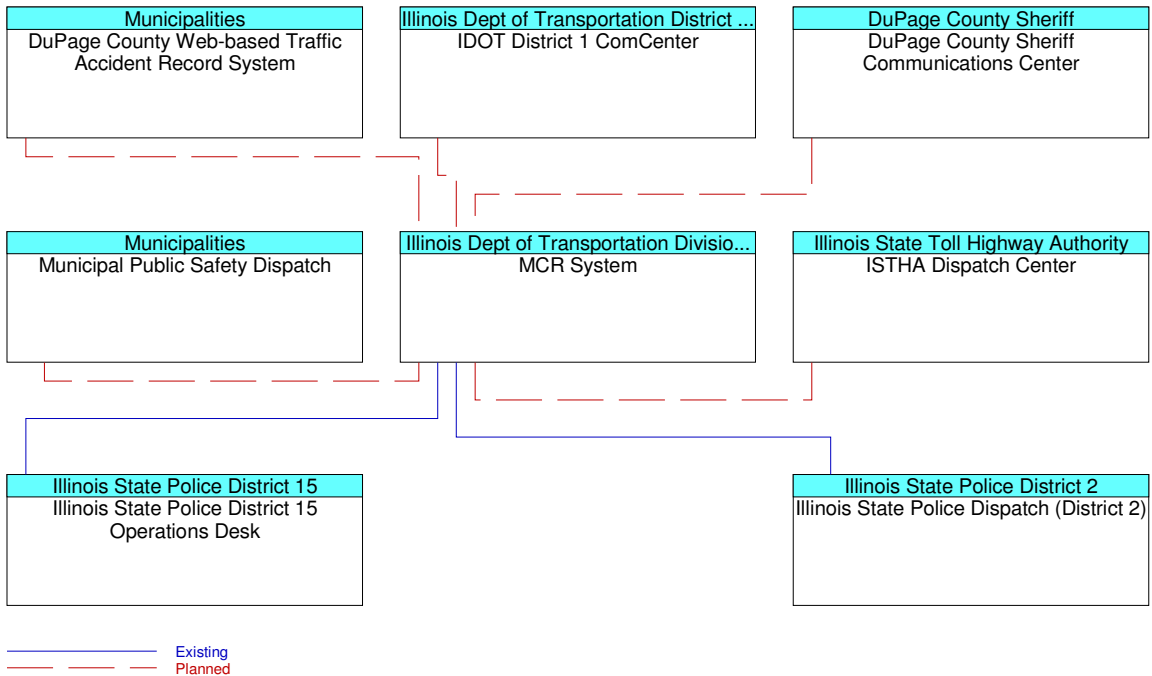

MCR System

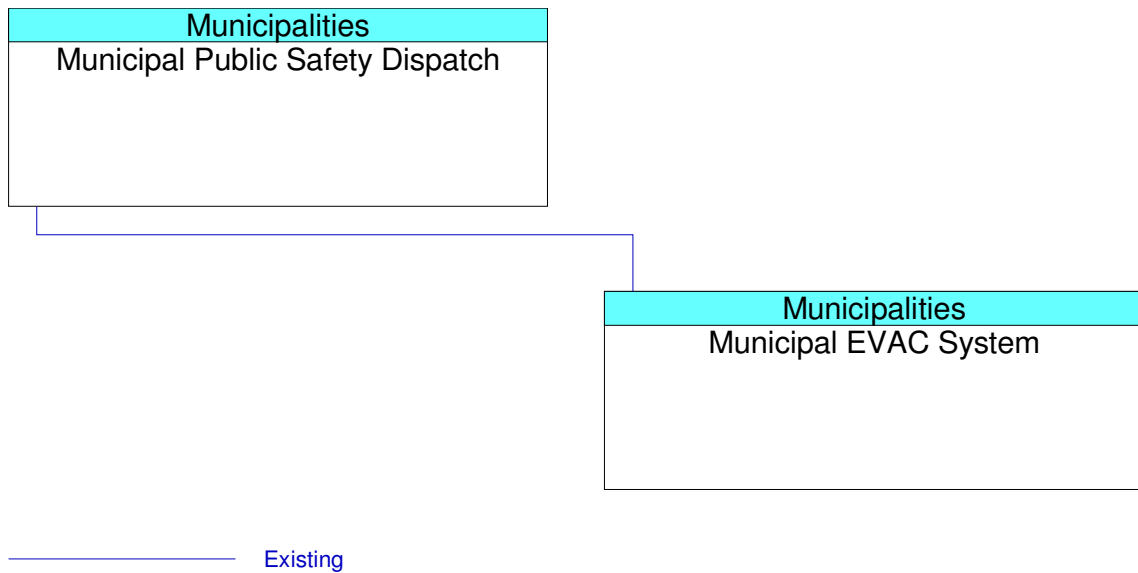

Municipal EVAC System

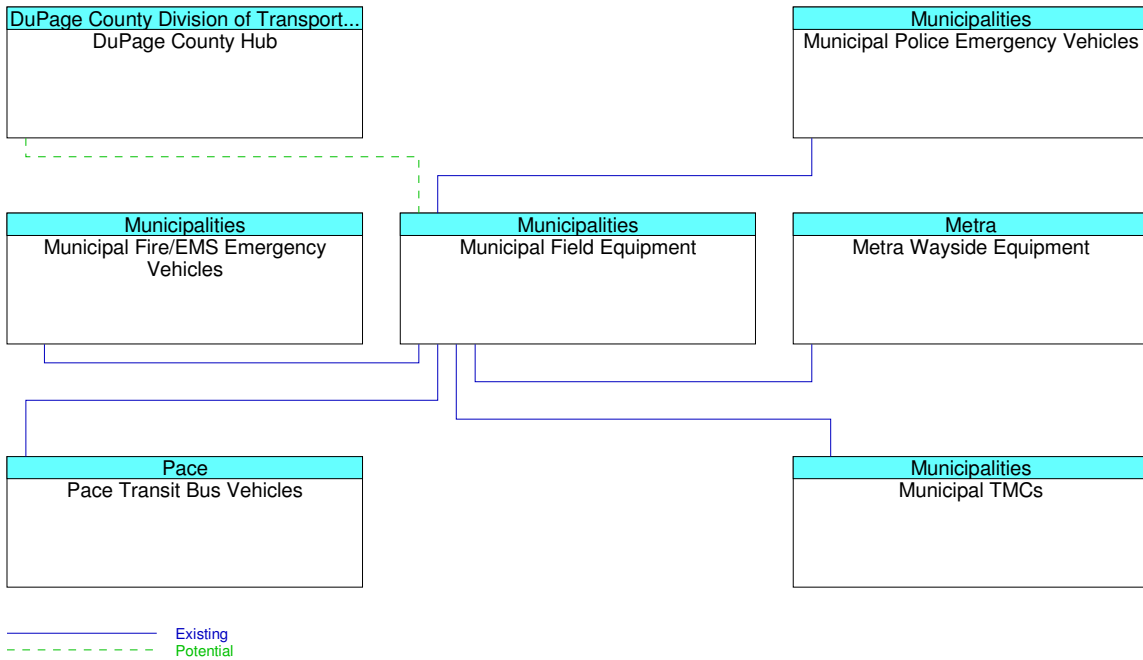

Municipal Field Equipment

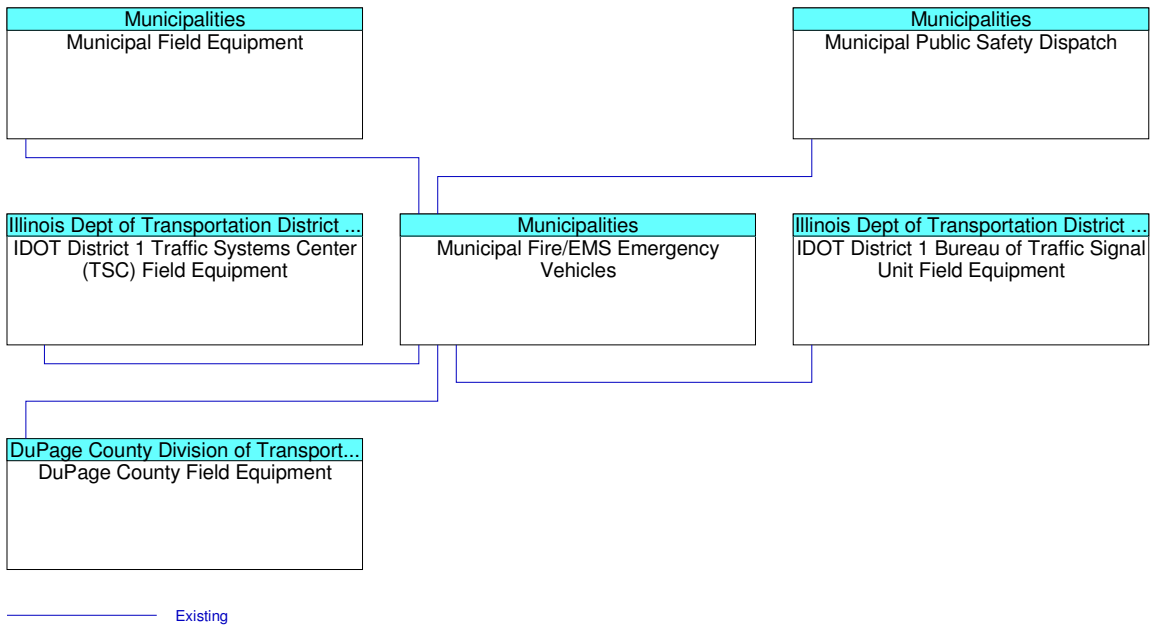

Municipal Fire/EMS Emergency Vehicle

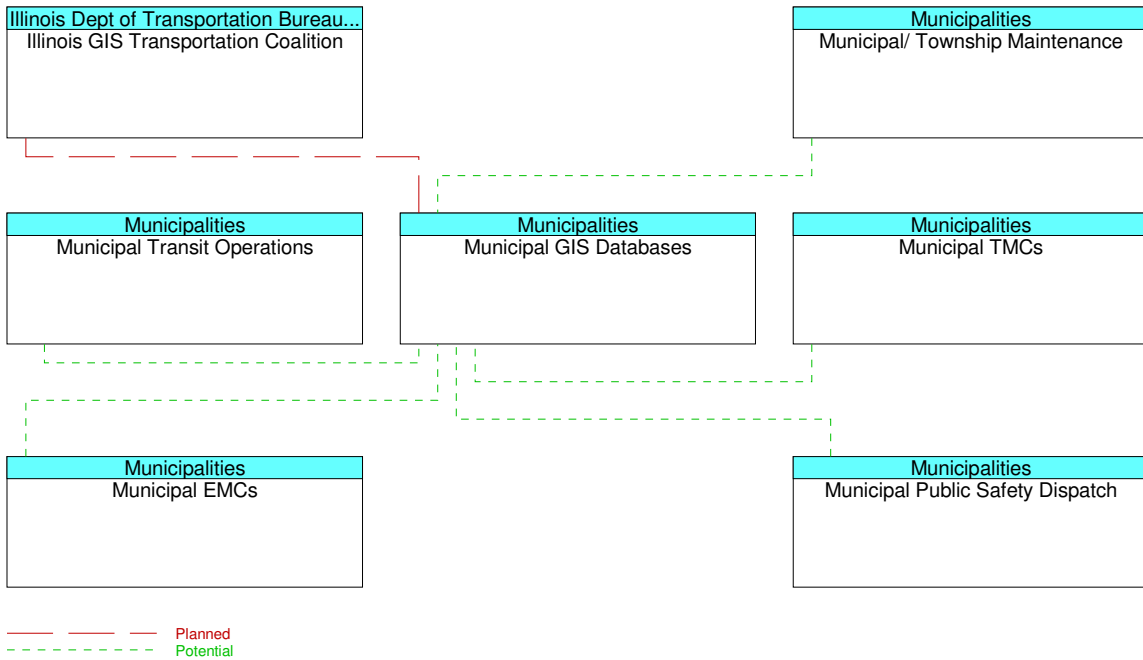

Municipal GIS Database

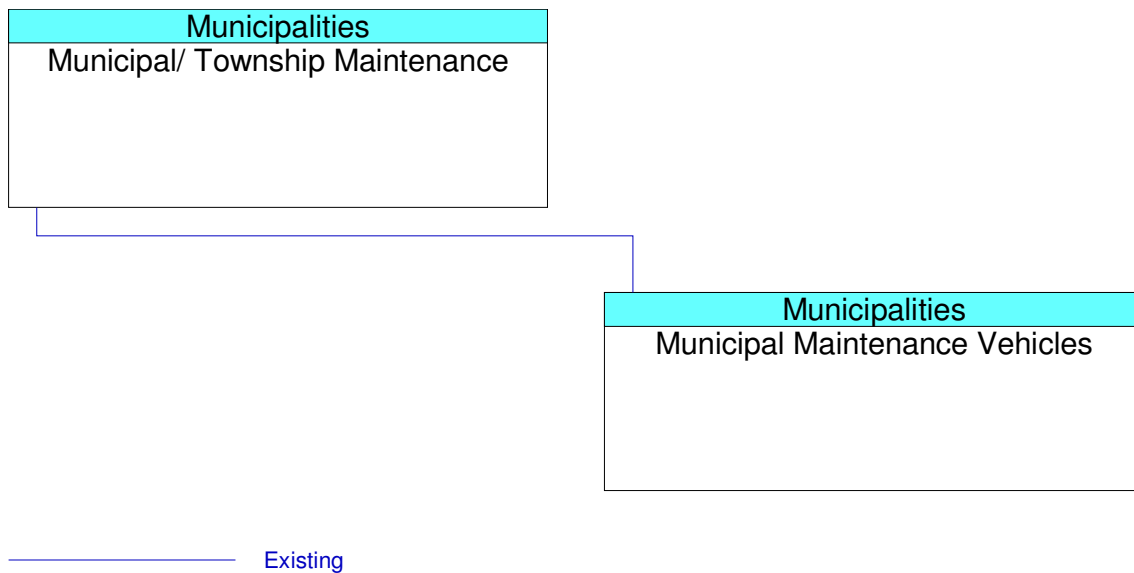

Municipal Maintenance Vehicles

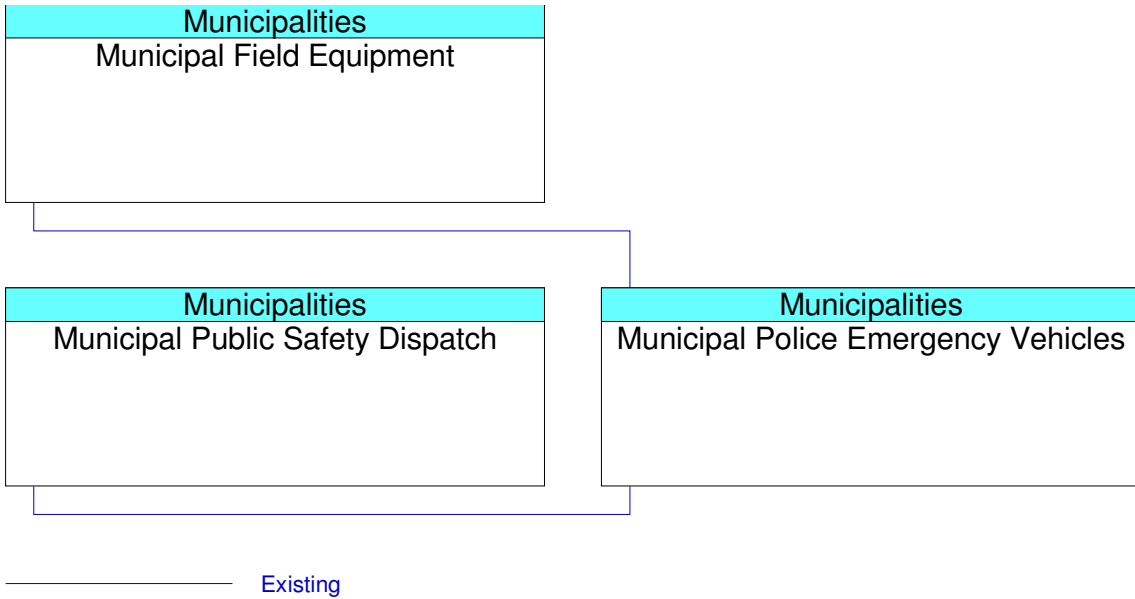

Municipal Police Emergency Vehicle

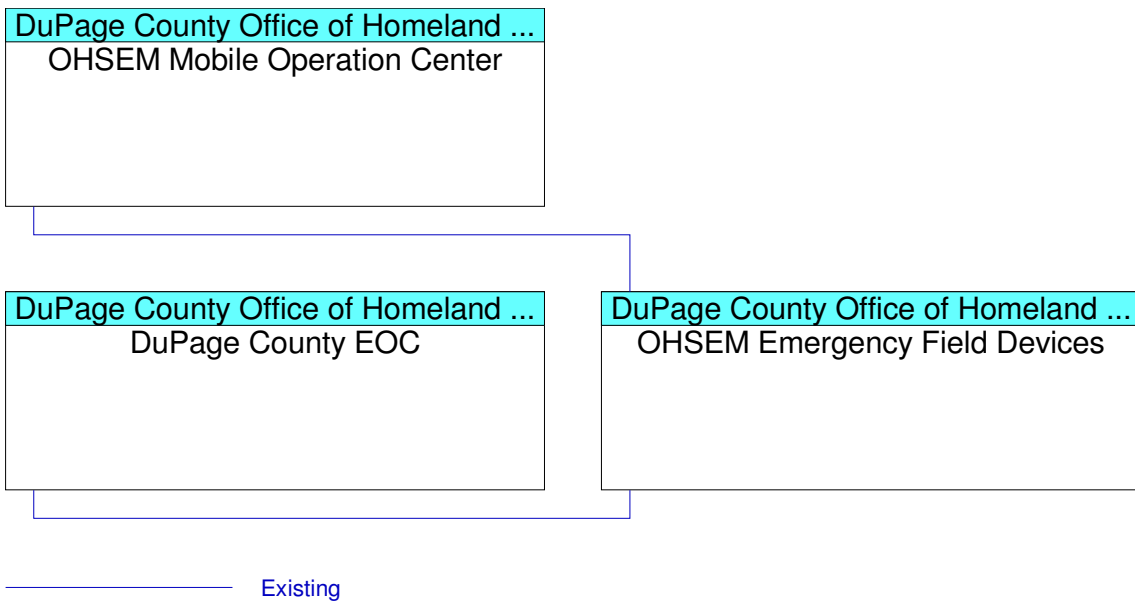

OHSEM Emergency Field Devices

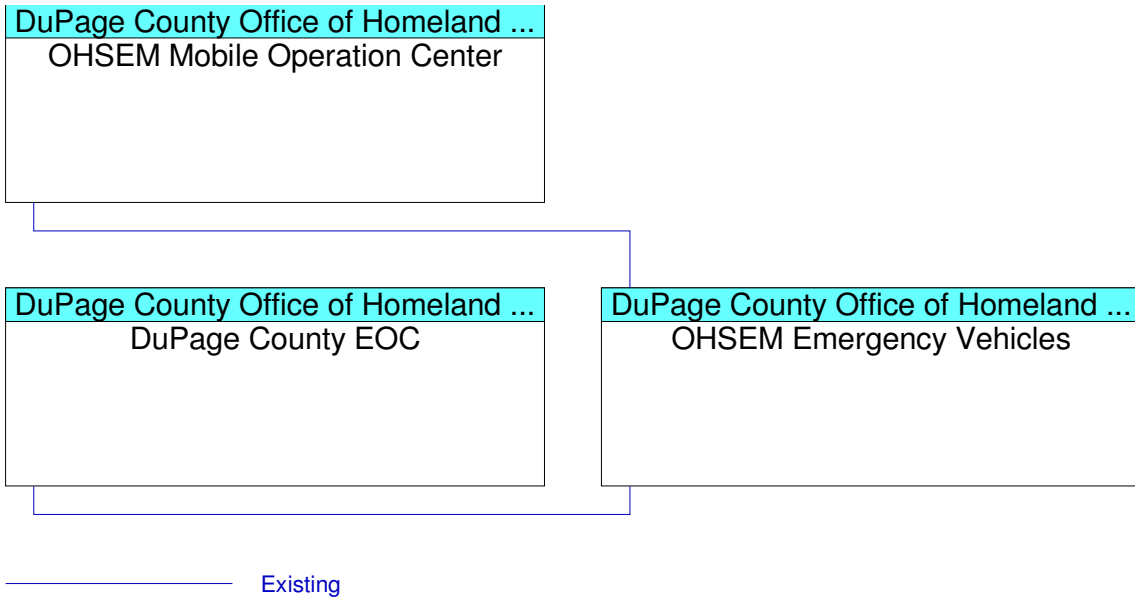

OHSEM Emergency Vehicles

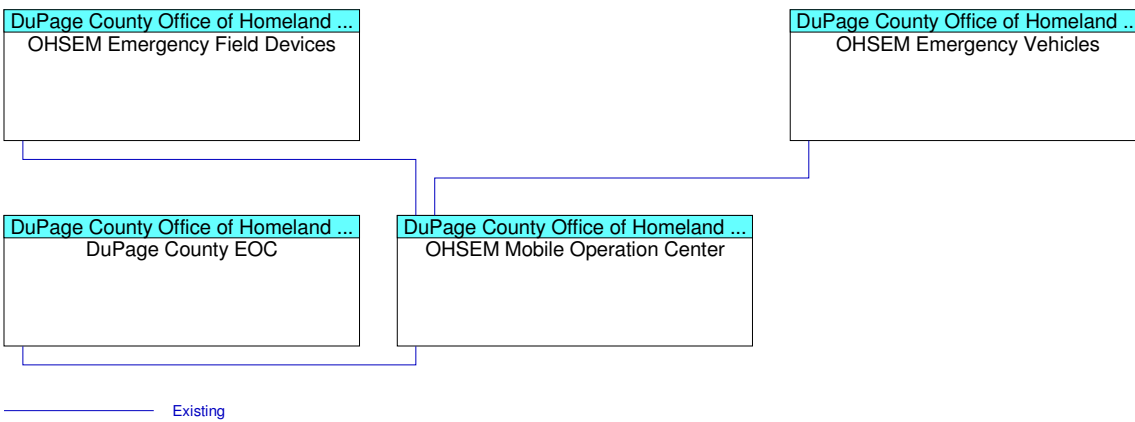

OHSEM Mobile Operation Center

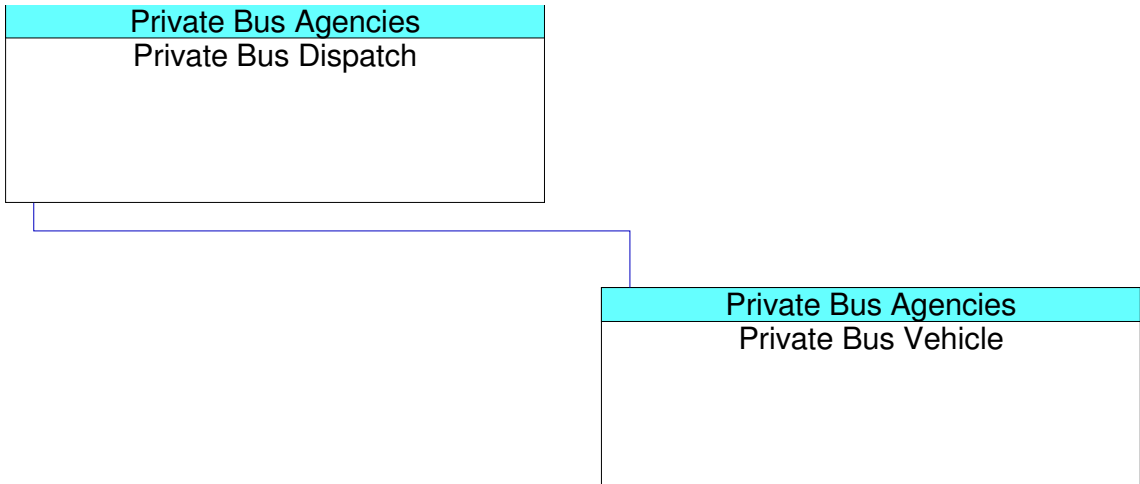

Existing

Private Bus Vehicle

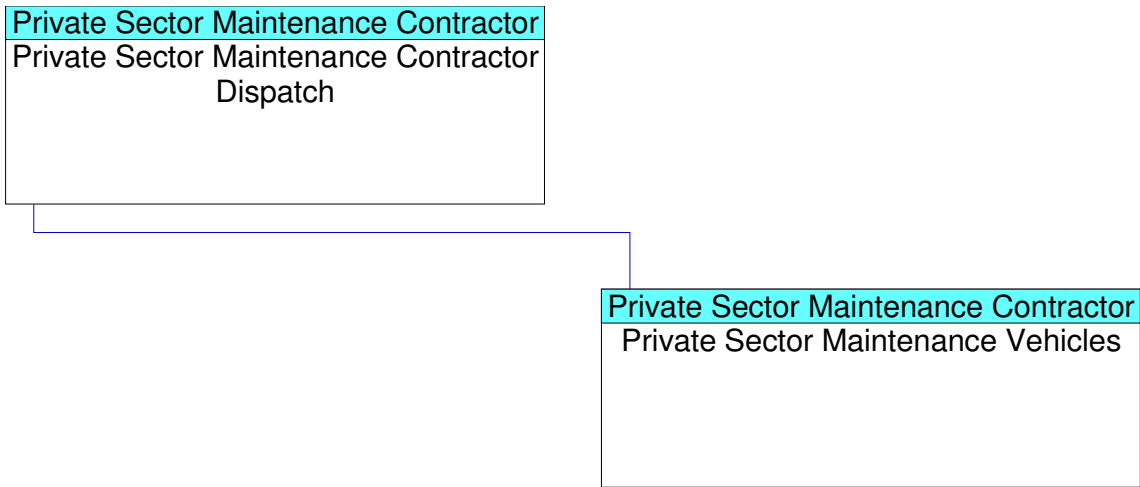

Existing

Private Sector Maintenance Vehicles

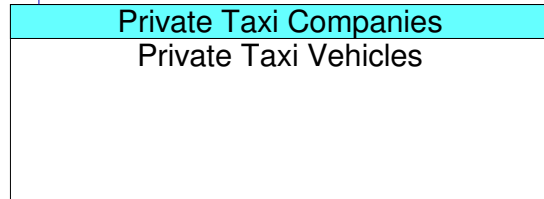
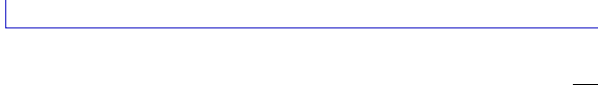
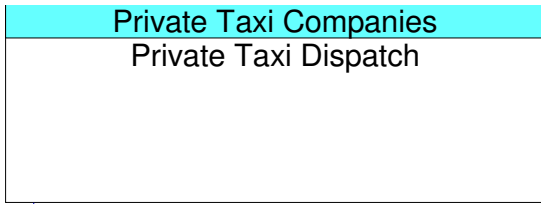

Existing

Private Taxi Vehicles

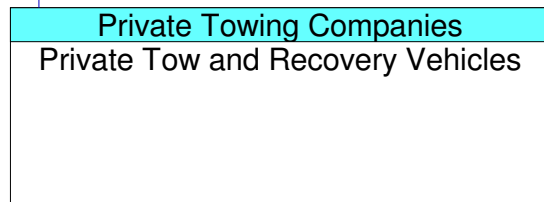
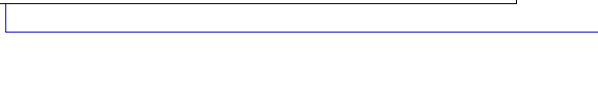
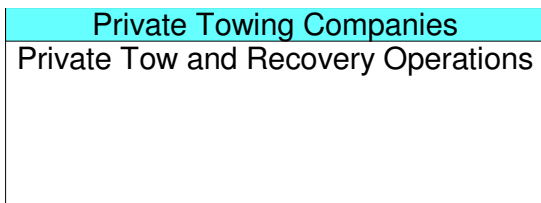

Existing

Private Tow and Recovery Vehicles

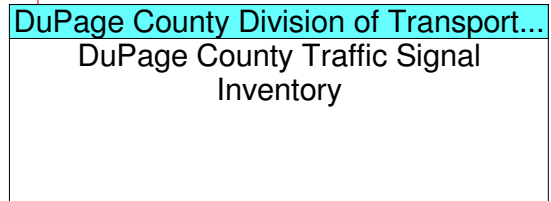
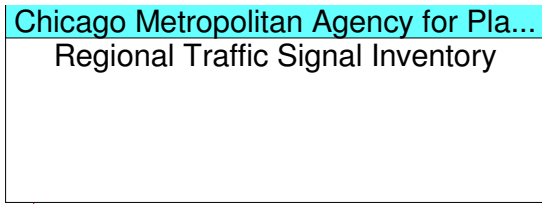

----- Planned

Regional Traffic Signal Inventory

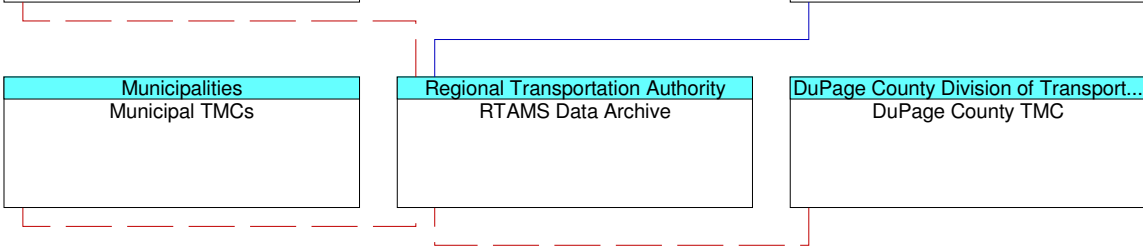
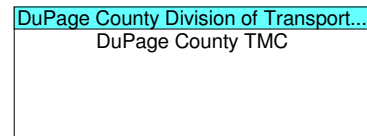
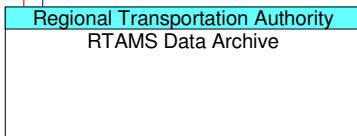
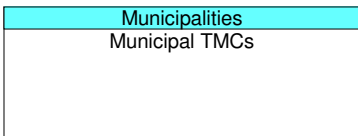
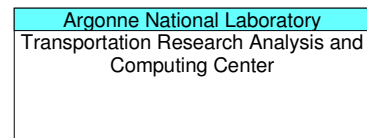
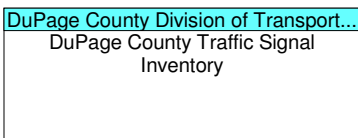

----- Existing
----- Planned

RTAMS Data Archive

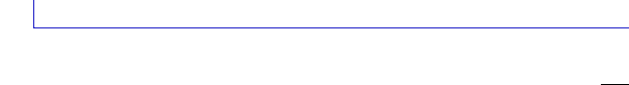
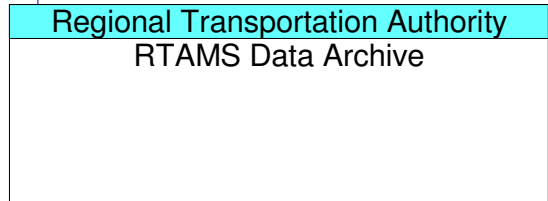
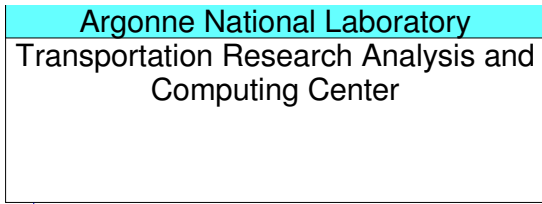

Existing

Transportation Research Analysis And Computing Center